



# GAMME TOITURES VÉRANDA / PERGOLA

**PROFILS ALUMINIUM  
GAMME DECLIC**



# DECLIC

## Profils polyvalents non porteurs

pour couvertures légères de pergolas

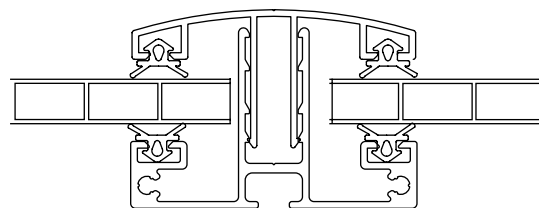

Avec la gamme de profils DECLIC, réalisez facilement et rapidement les couvertures légères pour pergolas aluminium.

Ces éléments non porteurs nécessitent une pose sur une structure porteuse primaire à réaliser au préalable.

### Éléments disponibles :

- Chevrons aluminium
- Rives aluminium
- Capots à clipper

### Compatibilité :

- Panneaux SUN ISOL®
- Plaques AKRA®THERM



Système exclusif



Polycarbonate alvéolaire de 10 à 32 mm



Pose sur structure porteuse obligatoire



Vis de sécurité obligatoire en partie basse

### Couleurs:



Alu  
Brut



Blanc  
9010



Marron  
1247



Ardoise  
7016 B



**Vue de coupe frontale du montage système**

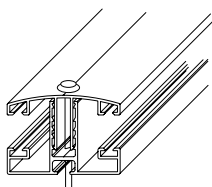
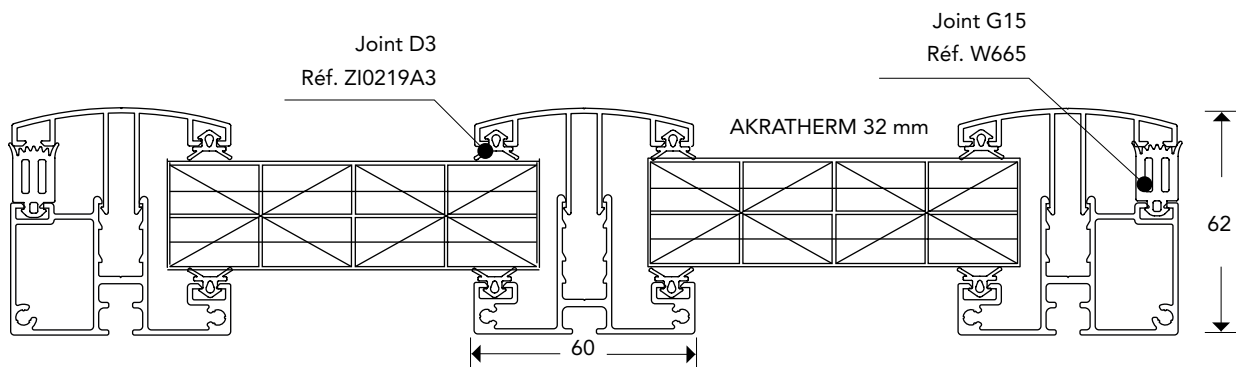
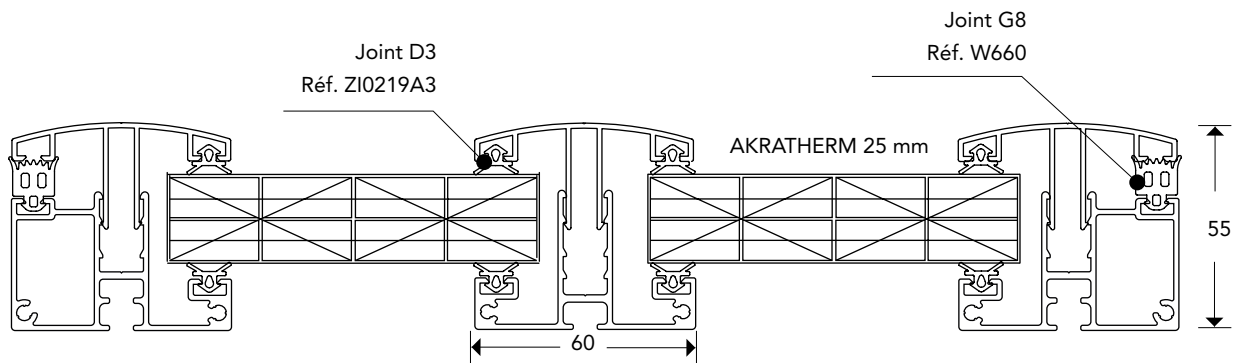
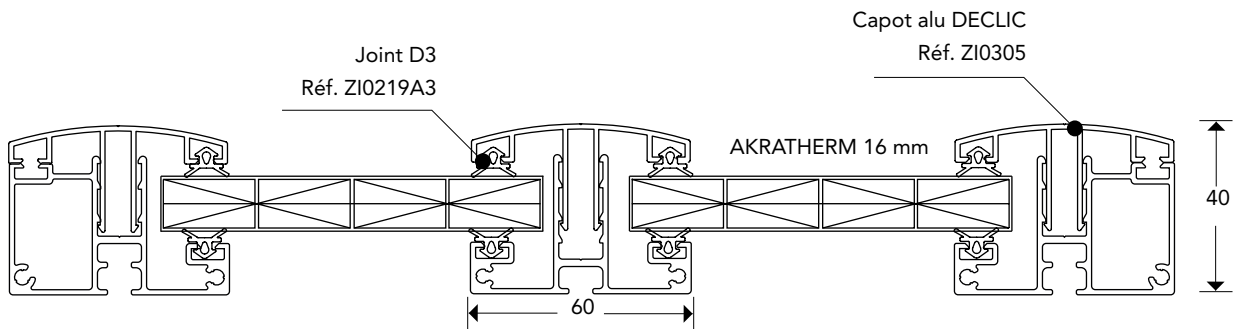
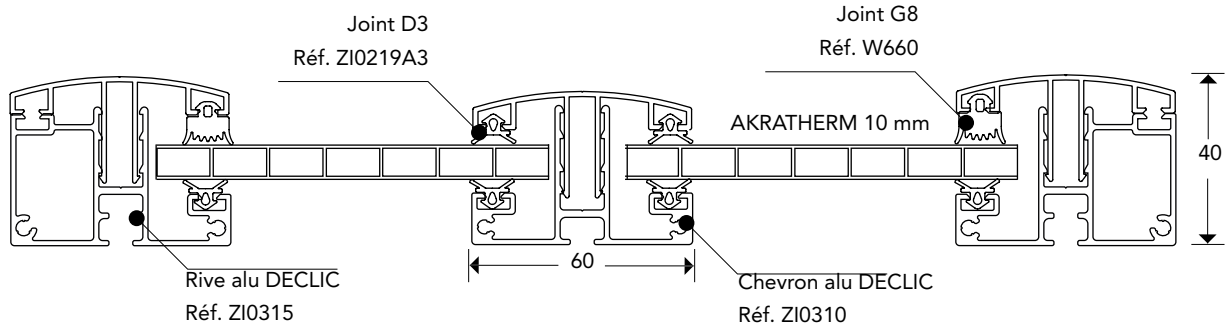

**Important : vis de sécurité obligatoire en partie basse**

Visuel	Code	Produit	Unité	Prix
Croquis	Article	Descriptif	Barre/ml	€/ml/Pce
	ZI0305A30	CAPOT ALU DECLIC <b>BRUT</b>	3,0 ML	
	ZI0305A40	CAPOT ALU DECLIC <b>BRUT</b>	4,0 ML	
	ZI0305A70	CAPOT ALU DECLIC <b>BRUT</b>	7,0 ML	
	ZI0305X30	CAPOT ALU DECLIC <b>COULEURS*</b>	3,0 ML	
	ZI0305X40	CAPOT ALU DECLIC <b>COULEURS*</b>	4,0 ML	
	ZI0305X70	CAPOT ALU DECLIC <b>COULEURS*</b>	7,0 ML	
	ZI0310A30	CHEVRON ALU DECLIC <b>BRUT</b>	3,0 ML	
	ZI0310A40	CHEVRON ALU DECLIC <b>BRUT</b>	4,0 ML	
	ZI0310A70	CHEVRON ALU DECLIC <b>BRUT</b>	7,0 ML	
	ZI0310X30	CHEVRON ALU DECLIC <b>COULEURS*</b>	3,0 ML	
	ZI0310X40	CHEVRON ALU DECLIC <b>COULEURS*</b>	4,0 ML	
	ZI0310X70	CHEVRON ALU DECLIC <b>COULEURS*</b>	7,0 ML	
	ZI0315A30	RIVE ALU DECLIC <b>BRUT</b>	3,0 ML	
	ZI0315A40	RIVE ALU DECLIC <b>BRUT</b>	4,0 ML	
	ZI0315A70	RIVE ALU DECLIC <b>BRUT</b>	7,0 ML	
	ZI0315X30	RIVE ALU DECLIC <b>COULEURS*</b>	3,0 ML	
	ZI0315X40	RIVE ALU DECLIC <b>COULEURS*</b>	4,0 ML	
	ZI0315X70	RIVE ALU DECLIC <b>COULEURS*</b>	7,0 ML	
	ZI0219A3	JOINT D3 x 50 ML	50 ML	
	W660-07000	JOINT G8 x 7 ML	PC	
	W665-07000	JOINT G15 x 7 ML	PC	
	ZI0319G1	EMBOUT DE CHEVRON DECLIC <b>BRUT</b>	PC	
	ZI0319GX	EMBOUT DE CHEVRON DECLIC <b>COULEURS*</b>	PC	

**Couleurs:**

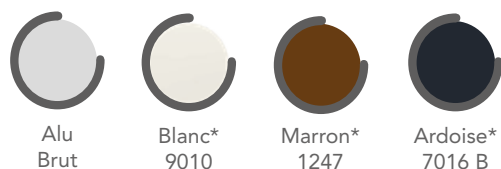

**Règles de sécurité :**

Sécurisation obligatoire par vis en partie basse du profil et pose sur structure porteuse obligatoire.



# GAMME TOITURES VÉRANDA / PERGOLA

---

**PROFILS ALUMINIUM  
ACCESSOIRES DIVERS**



## Profils pergola pour plaques AKRA®THERM de 25 à 32 MM

**Règle de sécurité :**

Pose sur structure porteuse obligatoire.

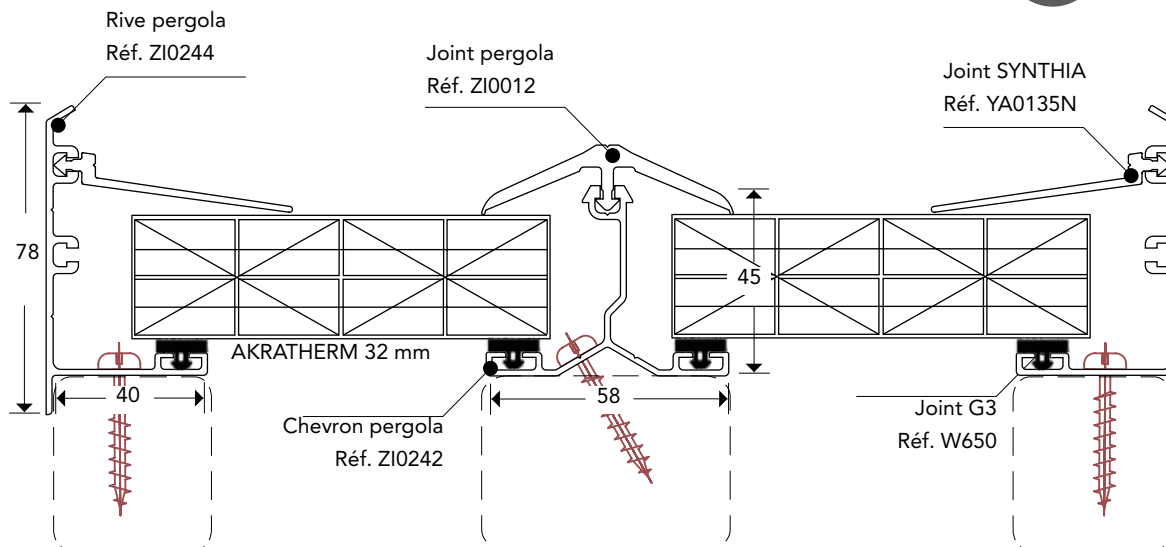

Visuel	Code	Produit	Unité	Prix
Croquis	Article	Descriptif	Barre/ml	€/ml/Pce

	ZI0242A75	CHEVRON PERGOLA 25/32 MM <b>BRUT</b>	7,5 ML	
	ZI0244B75	RIVE PERGOLA 25/32 MM <b>BLANC</b>	7,5 ML	
	ZI0244E75	RIVE PERGOLA 25/32 <b>BRUN 1247</b>	7,5 ML	
	ZI0012	JOINT PERGOLA x 25 ML EPDM <b>NOIR</b>	ML	
	YA0135N	JOINT SYNTHIA <b>NOIR</b>	ML	
	W650-00000	JOINT G3 x 50 ML <b>NOIR</b>	ML	
	ZI0219G1	ARRET PLAQUE 60x40 <b>BRUT</b>	PC	
	ZI0219G2	ARRET PLAQUE 60x40 <b>BLANC 9010</b>	PC	
	ZI0219G5	ARRET PLAQUE 60x40 <b>BRUN 1247</b>	PC	
	ZI0630A70	SABLIERE DEPORTEE ALU <b>BRUT</b>	7 ML	
	ZI0630B70	SABLIERE DEPORTEE ALU <b>BLANC 9010</b>	7 ML	
	ZI0630H70	SABLIERE DEPORTEE ALU <b>GRIS 7016 G</b>	7 ML	
	YA0120B70	SOLIN SYNTHIA <b>BLANC 9010</b>	7 ML	
	YA0120E70	SOLIN SYNTHIA <b>BRUN 1247</b>	7 ML	
	ZI0620D69	SABLIERE ALU <b>BRUT</b>	7 ML	
	ZI0620B69	SABLIERE ALU <b>BLANC 9010</b>	7 ML	
	YA0190A	JOINT PT. MOD POUR SABLIERE <b>NOIR</b> x 7 ML	PC	
	YA0152B	EMBOUT DE FAITIERE SYNTHIA <b>BLANC</b>	PC	
	YA0152E	EMBOUT DE FAITIERE SYNTHIA <b>BRUN 1247</b>	PC	

Disponibilités variables suivant les agences

Tarifs indicatifs et non contractuels s'adressant à des professionnels de la véranda et pergola

Règle de sécurité :

Pose sur structure porteuse obligatoire.

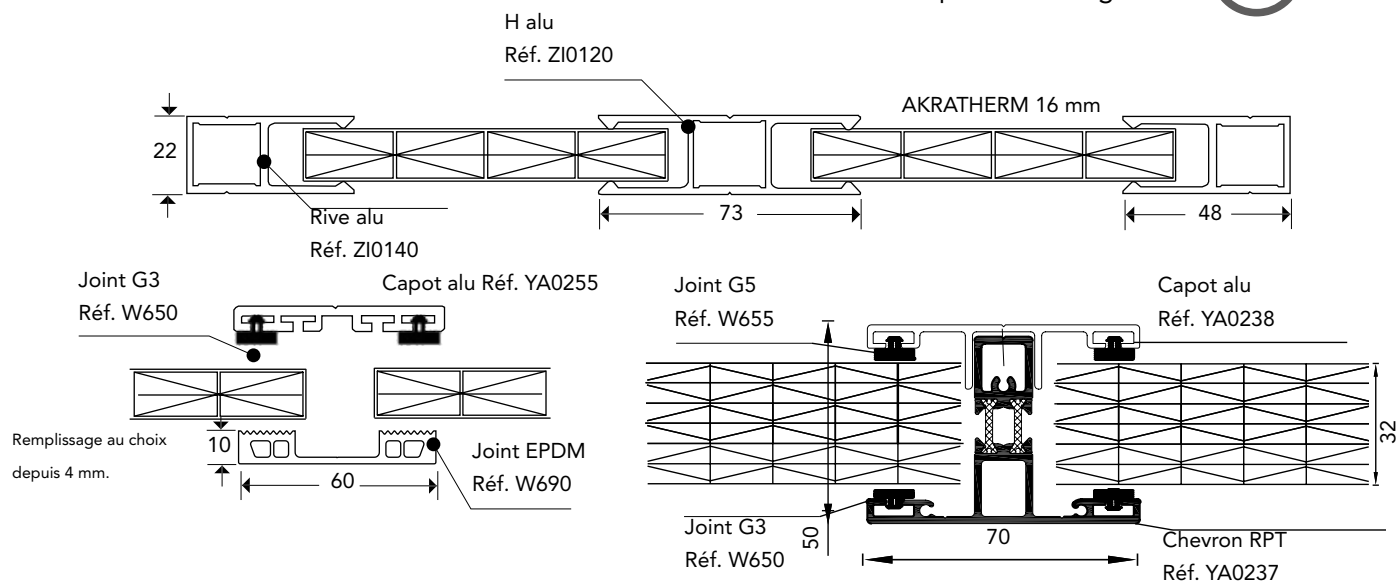

TOITURES VÉRANDA / PERGOLA

Visuel	Code	Produit	Unité	Prix
Croquis	Article	Descriptif	Barre/ml	€/ml/Pce
	ZI0140B69	RIVE ALU <b>BLANC 9010</b>	7 ML	
	ZI0120B69	PROFIL H ALU <b>BLANC 9010</b>	7 ML	
	YA0255B70	CAPOT ALU <b>BLANC 9010</b>	7 ML	
	W690-00050	JOINT EPDM <b>NOIR</b>	25 ML	
	W650-00000	JOINT G3 <b>NOIR</b>	50 ML	
	ZI0219G1	ARRET PLAQUE 60x40 <b>BRUT</b>	PC	
	ZI0219G2	ARRET PLAQUE 60x40 <b>BLANC 9010</b>	PC	
	ZI0219G5	ARRET PLAQUE 60x40 <b>BRUN 1247</b>	PC	
	YA0238A70	CAPOT ALU <b>BRUT</b>	7 ML	
	YA0238B70	CAPOT ALU <b>BLANC 9010</b>	7 ML	
	YA0238L70	CAPOT ALU <b>GRIS 7016 G</b>	7 ML	
	YA0237A70	CHEVRON RPT ALU <b>BRUT</b>	7 ML	
	YA0237B70	CHEVRON RPT ALU <b>BLANC 9010</b>	7 ML	
	YA0237L70	CHEVRON RPT ALU <b>GRIS 7016 G</b>	7 ML	
	W650-00000	JOINT G3 <b>NOIR</b>	50 ML	
	W650-07000	JOINT G3 x 7 ML	PC	
	W655-07000	JOINT G5 x 7 ML	PC	
	W662-07000	JOINT G11 x 7 ML	PC	
	WA90-00025	VIS INOX TCA2 4,8 x 25 MM	PC	
	YA0243A00	ARRET PLAQUE ALU 60x40 <b>BRUT</b>	PC	
	YA0243B00	ARRET PLAQUE ALU 60x40 <b>BLANC 9010</b>	PC	
	YA0243L00	ARRET PLAQUE ALU 60x40 <b>GRIS 7016 G</b>	PC	

Disponibilités variables suivant les agences

Tarifs indicatifs et non contractuels s'adressant à des professionnels de la véranda et pergola

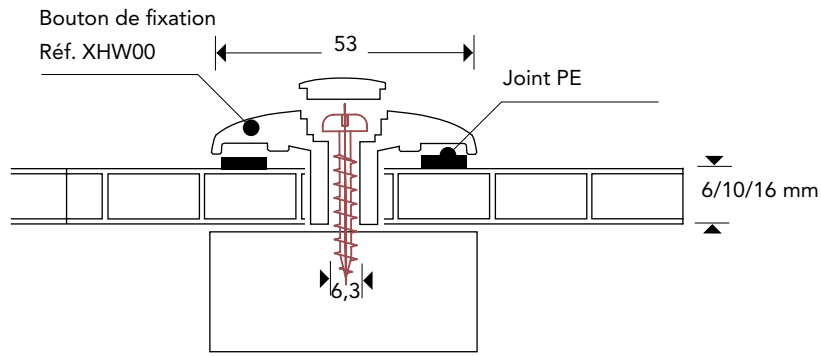

Visuel	Code	Produit	Unité	Prix
Croquis	Article	Descriptif	Barre/ML	€ / M L / Pce

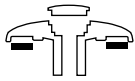

XHW00 BOUTON DE FIXATION PC ALVEOLAIRE POUR 6 MM / 10 MM / 16 MM

DISPONIBLE jusqu'à ÉPUISEMENT DES STOCKS

PC

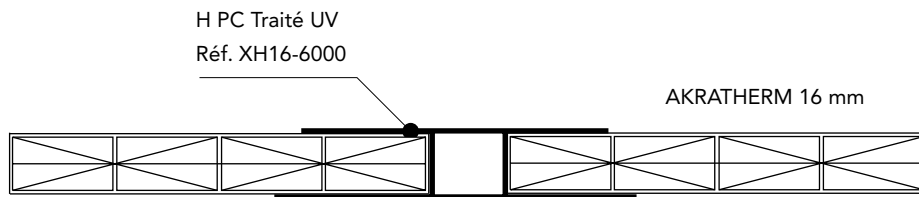

Visuel	Code	Produit	Unité	Prix
Croquis	Article	Descriptif	Barre/ML	€ / M L / Pce



XHU4-66000 OBTURATEUR PC 6 MM  
 XHU10-6000 OBTURATEUR PC 10 MM  
 XHU16-6000 OBTURATEUR PC 16 MM

6,0 ML  
 6,0 ML  
 6,0 ML

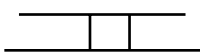



XH06-6001 PROFIL H 6 MM PC TRAITE UV  
 XH10-6000 PROFIL H 10 MM PC TRAITE UV  
 XH16-6000 PROFIL H 16 MM PC TRAITE UV

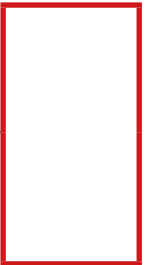

6,0 ML  
 6,0 ML  
 6,0 ML

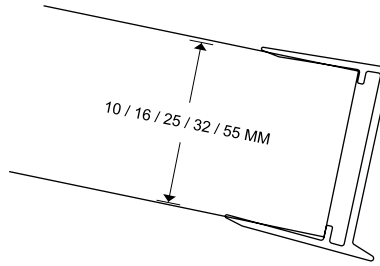





Visuel	Code	Produit	Unité	Prix
Croquis	Article	Descriptif	Barre/ML	€/ML
	W010	OBTURATEUR 10 MM <b>GRIS AS</b>	6,3 ML	
	W016	OBTURATEUR 16 MM <b>BRUT</b>	6,35 ML	
	W016	OBTURATEUR 16 MM <b>BLANC 9010</b>	6,35 ML	
	W016	OBTURATEUR 16 MM <b>BRUN 1247</b>	6,35 ML	
	W016	OBTURATEUR 16 MM <b>GRIS 7016G</b>	6,35 ML	
	W016	OBTURATEUR 16 MM <b>BRUT</b>	1,22 ML	
	W016	OBTURATEUR 16 MM <b>BLANC 9010</b>	1,22 ML	
	W016	OBTURATEUR 16 MM <b>BRUN 1247</b>	1,22 ML	
	W016	OBTURATEUR 16 MM <b>GRIS 7016G</b>	1,22 ML	
	W025	OBTURATEUR 25 MM <b>BRUT</b>	6,35 ML	
	W025	OBTURATEUR 25 MM <b>BLANC 9010</b>	6,35 ML	
	W032	OBTURATEUR 32 MM <b>BRUT</b>	6,2 ML	
	W032	OBTURATEUR 32 MM <b>BLANC 9010</b>	6,2 ML	
	W032	OBTURATEUR 32 MM <b>BRUN 1247</b>	6,2 ML	
	W032	OBTURATEUR 32 MM <b>GRIS 7016G</b>	6,2 ML	
	W032	OBTURATEUR 32 MM <b>BRUT</b>	1,23 ML	
	W032	OBTURATEUR 32 MM <b>BLANC 9010</b>	1,23 ML	
	W032	OBTURATEUR 32 MM <b>BRUN 1247</b>	1,23 ML	
	W032	OBTURATEUR 32 MM <b>GRIS 7016G</b>	1,23 ML	
	W055	OBTURATEUR 55 MM <b>BRUT</b>	1,25 ML	
W055	OBTURATEUR 55 MM <b>BLANC 9010</b>	1,25 ML		
W055	OBTURATEUR 55 MM <b>GRIS 7016G</b>	1,25 ML		

Visuel	Code	Produit	Unité	Prix
Croquis	Article	Descriptif	Barre/ML	€/Pce
	XHV25-55	RUBAN ADH. ALU 25MM x 50 M POUR 6/10 MM	PC	
	XHV38-50	RUBAN ADH. ALU 38MM x 50 M POUR 16/20 MM	PC	
	XHV50-55	RUBAN ADH. ALU 50MM x 50 M POUR 25/32 MM	PC	
	XHV75-50	RUBAN ADH. ALU 75MM x 50 M POUR 55 MM	PC	
	XHV25-35	RUBAN ADH. AJOU 25MM x 33 M POUR 10 MM	PC	
	XHV38-10	RUBAN ADH. AJOU 38MM x 10 M POUR 16/20 MM	PC	
	XHV38-33	RUBAN ADH. AJOU 38MM x 33 M POUR 16/20 MM	PC	
	XHV50-10	RUBAN ADH. AJOU 50MM x 10 M POUR 25/32 MM	PC	
	XHV50-33	RUBAN ADH. AJOU 50MM x 33 M POUR 25/32 MM	PC	
	XHV80-33	RUBAN ADH. AJOU 75MM x 33 M POUR 55 MM	PC	
V080-A0050	MEMBRANE LIQUIDE SP925	PC		
V080-A1500	PINCEAU	PC		

Disponibilités variables suivant les agences  
 Tarifs indicatifs et non contractuels s'adressant à des professionnels de la véranda et pergola

## SUN TOP

### Profils polyvalents non porteurs

pour couvertures fines et/ou cintrées

Avec la gamme de profils SUN TOP, réalisez facilement et rapidement les couvertures légères pour bâtiments industriels, serres, ...

Ces éléments non porteurs nécessitent une pose sur une structure porteuse primaire à réaliser au préalable.

La gamme SUN TOP peut être cintrée pour la réalisation de voûtes.

#### Éléments disponibles :

- Chevrons aluminium
- Capots à visser

#### Compatibilité :

- Plaques AKRA®THERM
- Plaques acrylique compactes
- Plaques polycarbonate compactes



Système exclusif



Polycarbonate compact  
Acrylique compact  
de 3 à 20 mm



Polycarbonate alvéolaire  
de 10 à 32 mm



Profils aluminium cintrables



Pose sur structure porteuse  
obligatoire







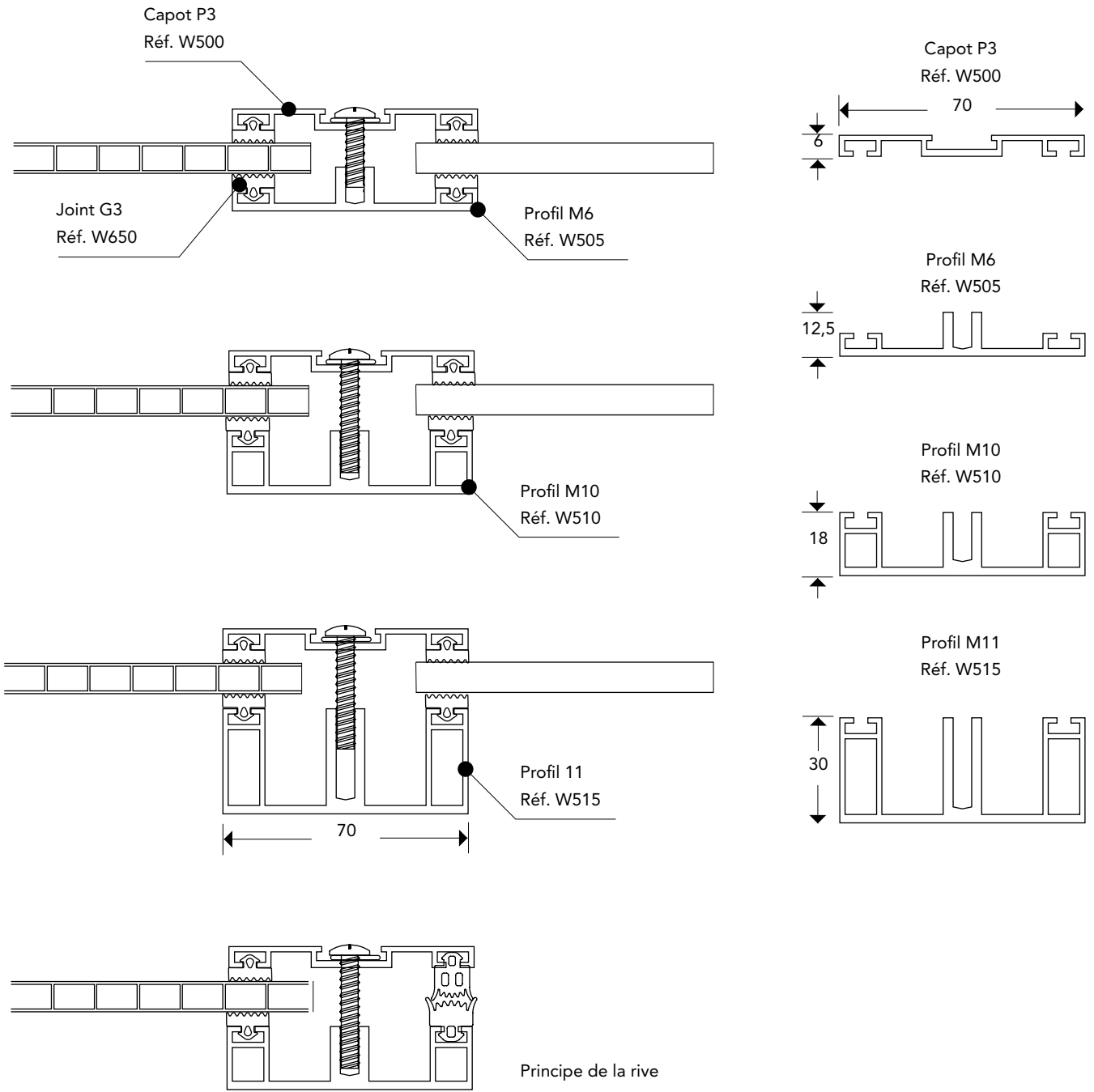



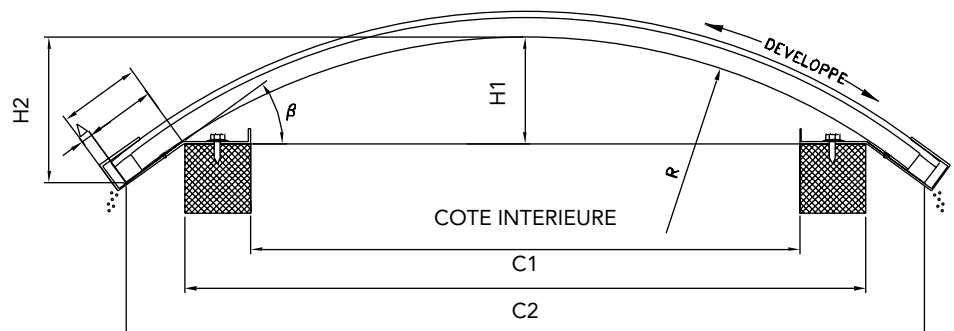

**Vue de coupe frontale du montage système**

BÂTIMENT

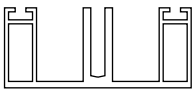

**Principe de la voûte cintrée**



Visuel Croquis	Code Article	Produit Descriptif	Unité Barre/ML	Prix € / M L / Pce
	W500-A7000	CAPOT ALU P3 ANODISE <b>AS</b>	7,0 ML	
	W505-A7000	PROFIL ALU M6 ANODISE <b>AS</b>	7,0 ML	
	W510-A7000	PROFIL ALU M10 ANODISE <b>AS</b>	7,0 ML	
	W515-A7000	PROFIL ALU M11 ANODISE <b>AS</b>	7,0 ML	
	W650-07000	JOINT G3 x 7 ML	PC	
	W650-00000	JOINT G3 x 50 ML	ML	
	W655-07000	JOINT G5 x 7 ML	PC	
	W660-07000	JOINT G8 x 7 ML	PC	
	W790	ARRET DE PLAQUE 60x40	PC	
	W699-00020	VIS CHC INOX M6x20	100 PC	
	W699-00025	VIS CHC INOX M6x25	100 PC	
	W700-00000	VIS CHC INOX M6x30	100 PC	
	W705-00000	VIS CHC INOX M6x35	100 PC	
	W710-00045	VIS CHC INOX M6x45	100 PC	
	W715-00000	VIS CHC INOX M6x50	100 PC	
	W750-00000	RONDELLE VULCA 16x6,3	100 PC	

Épaisseur (mm)	3	4	5	6	8	10	16	25	32
<b>P3 + M6 + G3</b>	6x16	6x16	6x18	6x18	6x20	6x20	6x30	6x35	6x45
<b>P3 + M10 + G3</b>	6x20	-	6x25	6x25	6x25	6x30	6x35	6x45	6x50
<b>P3 + M11 + G3</b>	6x20	-	6x25	6x25	6x25	6x30	6x35	6x45	6x50



**Règle de sécurité :**  
Pose sur structure porteuse obligatoire.